

Ambient Light Sensor, RoHS Compliant, Released for Lead (Pb)-free Reflow Soldering, AEC-Q101 Released

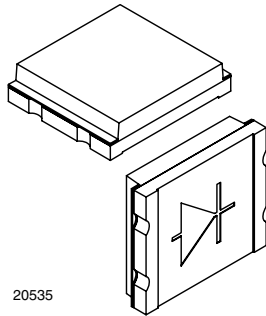

20535

DESCRIPTION

TEMD5510FX01 ambient light sensor is a PIN photodiode with high photo sensitivity in a miniature surface mount device (SMD). The detector chip has 7.5 mm² sensitive area. It is sensitive to visible light much like the human eye and has peak sensitivity at 540 nm.

FEATURES

- Package type: surface mount
- Package form: top view
- Dimensions (L x W x H in mm): 5 x 4.24 x 1.12
- Radiant sensitive area (in mm²): 7.5
- Product designed and qualified acc. AEC-Q101 for the automotive market
- High photo sensitivity
- Adapted to human eye responsivity
- Supression filter for near infrared radiation
- Angle of half sensitivity: $\varphi = \pm 65^\circ$
- Floor life: 72 h, MSL 4, acc. J-STD-020
- Lead (Pb)-free reflow soldering
- Lead (Pb)-free component in accordance with RoHS 2002/95/EC and WEEE 2002/96/EC

RoHS
COMPLIANT

APPLICATIONS

- Automotive sensors
- Ambient light sensors
- Backlight dimmers
- Notebooks
- Computers

PRODUCT SUMMARY

COMPONENT	I_{ra} (μA)	φ (deg)	$\lambda_{0.5}$ (nm)
TEMD5510FX01	26	± 65	430 to 610

Note

Test conditions see table "Basic Characteristics"

ORDERING INFORMATION

ORDERING CODE	PACKAGING	REMARKS	PACKAGE FORM
TEMD5510FX01	Tape and reel	MOQ: 1500 pcs, 1500 pcs/reel	Top view

Note

MOQ: minimum order quantity

ABSOLUTE MAXIMUM RATINGS

PARAMETER	TEST CONDITION	SYMBOL	VALUE	UNIT
Reverse voltage		V_R	16	V
Power dissipation	$T_{amb} \leq 25^\circ C$	P_V	215	mW
Junction temperature		T_j	100	$^\circ C$
Operating temperature range		T_{amb}	- 40 to + 100	$^\circ C$
Storage temperature range		T_{stg}	- 40 to + 100	$^\circ C$
Soldering temperature	Acc. reflow solder profile fig. 5	T_{sd}	260	$^\circ C$
Thermal resistance junction/ambient	Soldered on PCB with pad dimensions: 4 mm x 4 mm	R_{thJA}	350	K/W

Note
 $T_{amb} = 25^\circ C$, unless otherwise specified

BASIC CHARACTERISTICS						
PARAMETER	TEST CONDITION	SYMBOL	MIN.	TYP.	MAX.	UNIT
Breakdown voltage	$I_R = 100 \mu A, E = 0$	$V_{(BR)}$	16			V
Reverse dark current	$V_R = 10 V, E = 0$	I_{ro}		2	30	nA
Diode capacitance	$V_R = 0 V, f = 1 MHz, E = 0$	C_D		1600		pF
	$V_R = 3 V, f = 1 MHz, E = 0$	C_D		730	40	pF
Reverse light current	$E_e = 1 mW/cm^2, \lambda = 550 nm, V_R = 5 V$	I_{ra}		26		μA
	$E_v = 100 lx, CIE illuminant A, V_R = 5 V$	I_{ra}	0.8	1		μA
Angle of half sensitivity		ϕ		± 65		deg
Wavelength of peak sensitivity		λ_p		540		nm
Range of spectral bandwidth		$\lambda_{0.5}$		430 to 610		nm

Note

$T_{amb} = 25 \text{ }^\circ C$, unless otherwise specified

BASIC CHARACTERISTICS

$T_{amb} = 25 \text{ }^\circ C$, unless otherwise specified

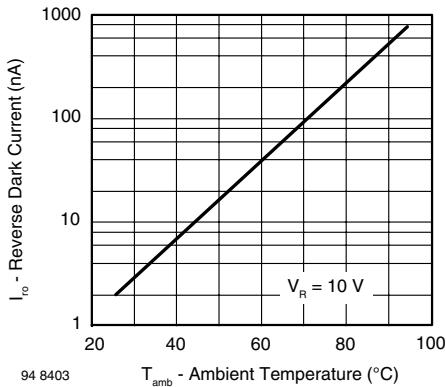

Fig. 1 - Reverse Dark Current vs. Ambient Temperature

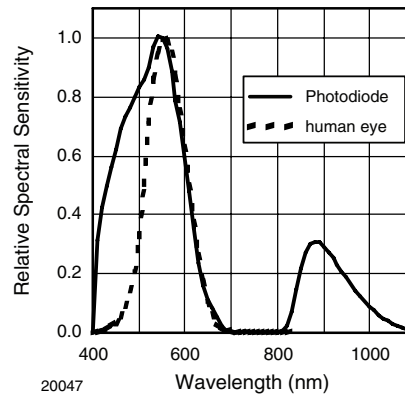

Fig. 3 - Relative Spectral Sensitivity vs. Wavelength

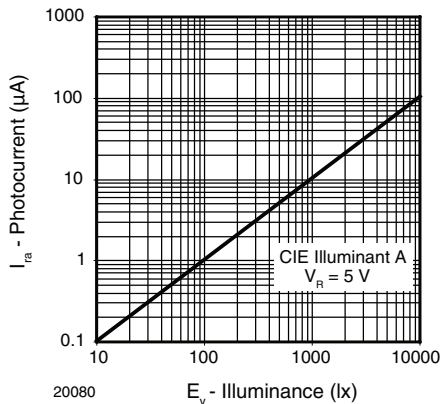

Fig. 2 - Reverse Light Current vs. Irradiance

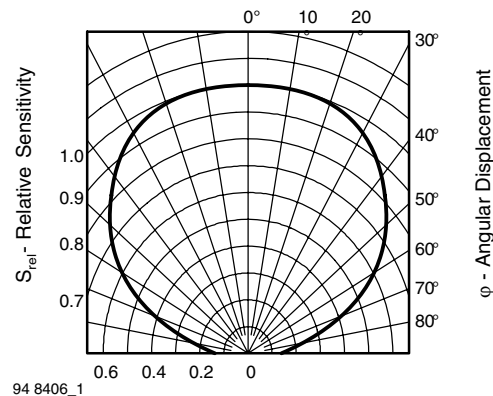

Fig. 4 - Relative Radiant Sensitivity vs. Angular Displacement



TEMD5510FX01

Ambient Light Sensor, RoHS Compliant, Released for Vishay Semiconductors
Lead (Pb)-free Reflow Soldering, AEC-Q101 Released

PACKAGE DIMENSIONS in millimeters

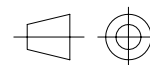
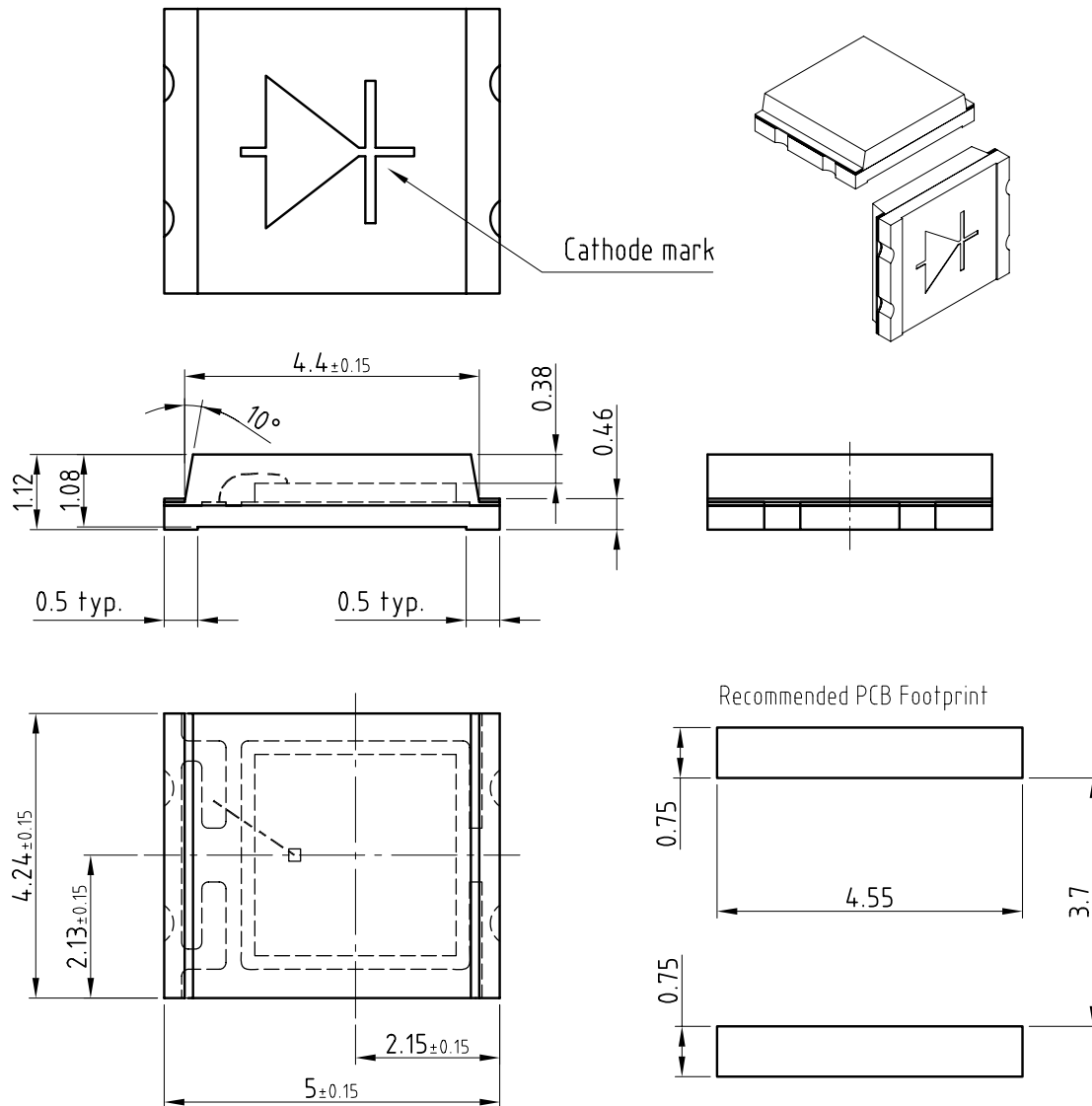

technical drawings
according to DIN
specifications

Drawing-No.: 6.541-5060.01-4
Issue: 3; 05.02.08
20536

Not indicated tolerances ± 0.1



SOLDER PROFILE

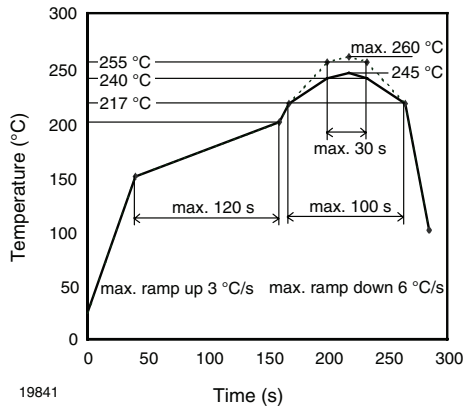

19841

Fig. 5 - Lead (Pb)-free Reflow Solder Profile
acc. J-STD-020D

DRYPACK

Devices are packed in moisture barrier bags (MBB) to prevent the products from moisture absorption during transportation and storage. Each bag contains a desiccant.

FLOOR LIFE

Time between soldering and removing from MBB must not exceed the time indicated in J-STD-020:

Moisture sensitivity: level 4

Floor life: 72 h

Conditions: $T_{amb} < 30\text{ °C}$, $RH < 60\%$

DRYING

In case of moisture absorption devices should be baked before soldering. Conditions see J-STD-020 or recommended conditions:

192 h at 40 °C (+ 5 °C), $RH < 5\%$

or

96 h at 60 °C (+ 5 °C), $RH < 5\%$.



Disclaimer

All product specifications and data are subject to change without notice.

Vishay Intertechnology, Inc., its affiliates, agents, and employees, and all persons acting on its or their behalf (collectively, "Vishay"), disclaim any and all liability for any errors, inaccuracies or incompleteness contained herein or in any other disclosure relating to any product.

Vishay disclaims any and all liability arising out of the use or application of any product described herein or of any information provided herein to the maximum extent permitted by law. The product specifications do not expand or otherwise modify Vishay's terms and conditions of purchase, including but not limited to the warranty expressed therein, which apply to these products.

No license, express or implied, by estoppel or otherwise, to any intellectual property rights is granted by this document or by any conduct of Vishay.

The products shown herein are not designed for use in medical, life-saving, or life-sustaining applications unless otherwise expressly indicated. Customers using or selling Vishay products not expressly indicated for use in such applications do so entirely at their own risk and agree to fully indemnify Vishay for any damages arising or resulting from such use or sale. Please contact authorized Vishay personnel to obtain written terms and conditions regarding products designed for such applications.

Product names and markings noted herein may be trademarks of their respective owners.